

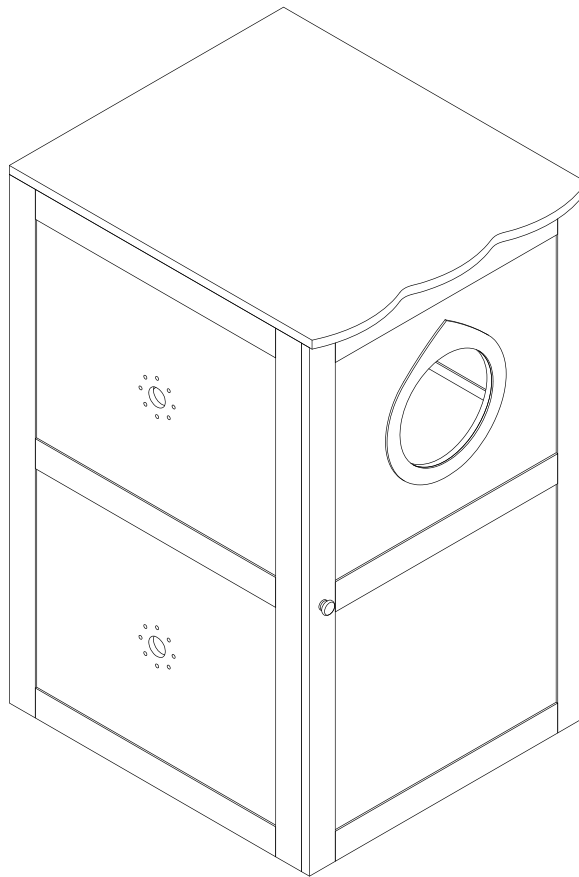









TRIXIE

Assembly and Care Instruction Double Decker Cat house





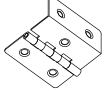

Item No.		Color	Code
4024	Doubel Decker Cat House	white	0
		espresso-brown	1
		gray	2

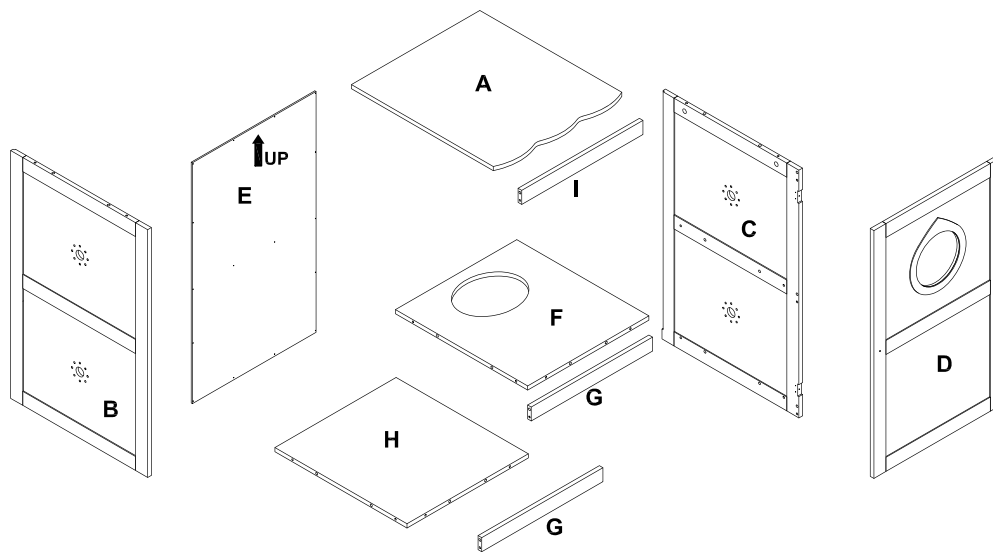
Pos. No.	Description	Measurement	Quantity	Item No. 0	Item No. 1	Item No. 2
Pos. A	Top Panel	20.75 × 23.75 × 0.5 in. (53 × 60.5 × 1.5 cm)	1	40240-10	40241-10	40242-10
Pos. B	Left Side Panel	22.25 × 34.75 × 0.5 in. (57 × 88.5 × 1.5 cm)	1	40240-11	40241-11	40242-11
Pos. C	Right Side Panel	22.25 × 34.75 × 0.5 in. (57 × 88.5 × 1.5 cm)	1	40240-12	40241-12	40242-12
Pos. D	Door Panel	20.5 × 34.25 × 0.5 in. (52.5 × 87.5 × 1.5 cm)	1	40240-13	40241-13	40242-13
Pos. E	Back Panel	20.25 × 33.75 × 0.2 in. (51.5 × 86 × 0.5 cm)	1	40240-14	40241-14	40242-14
Pos. F	Shelf Panel	21.75 × 19.25 × 0.5 in. (55.5 × 49.5 × 1.5 cm)	1	40240-20	40241-20	40242-20
Pos. G	Lower Apron	19.25 × 1.75 × 0.5 in. (49.5 × 4.5 × 1.5 cm)	2	40240-21	40241-21	40242-21
Pos. H	Bottom Panel	21.75 × 19.25 × 0.5 in. (55.5 × 49.5 × 1.5 cm)	1	40240-22	40241-22	40242-22
Pos. I	Lower Apron	19.25 × 2.36 × 0.5 in. (49.5 × 6.0 × 1.5 cm)	1	40240-23	40241-23	40242-23

Pos.1	Pos.2	Pos.3	Pos.4	Pos.5	Pos.6	Pos.7	Pos.8	Pos.9	Pos.10
									
x 22 pcs	x 22 pcs	x 22 pcs	x 2 pcs	x 2 pcs	x 16 pcs	x 1 pc	x 1 pc	x 2 pcs	x 16 pcs







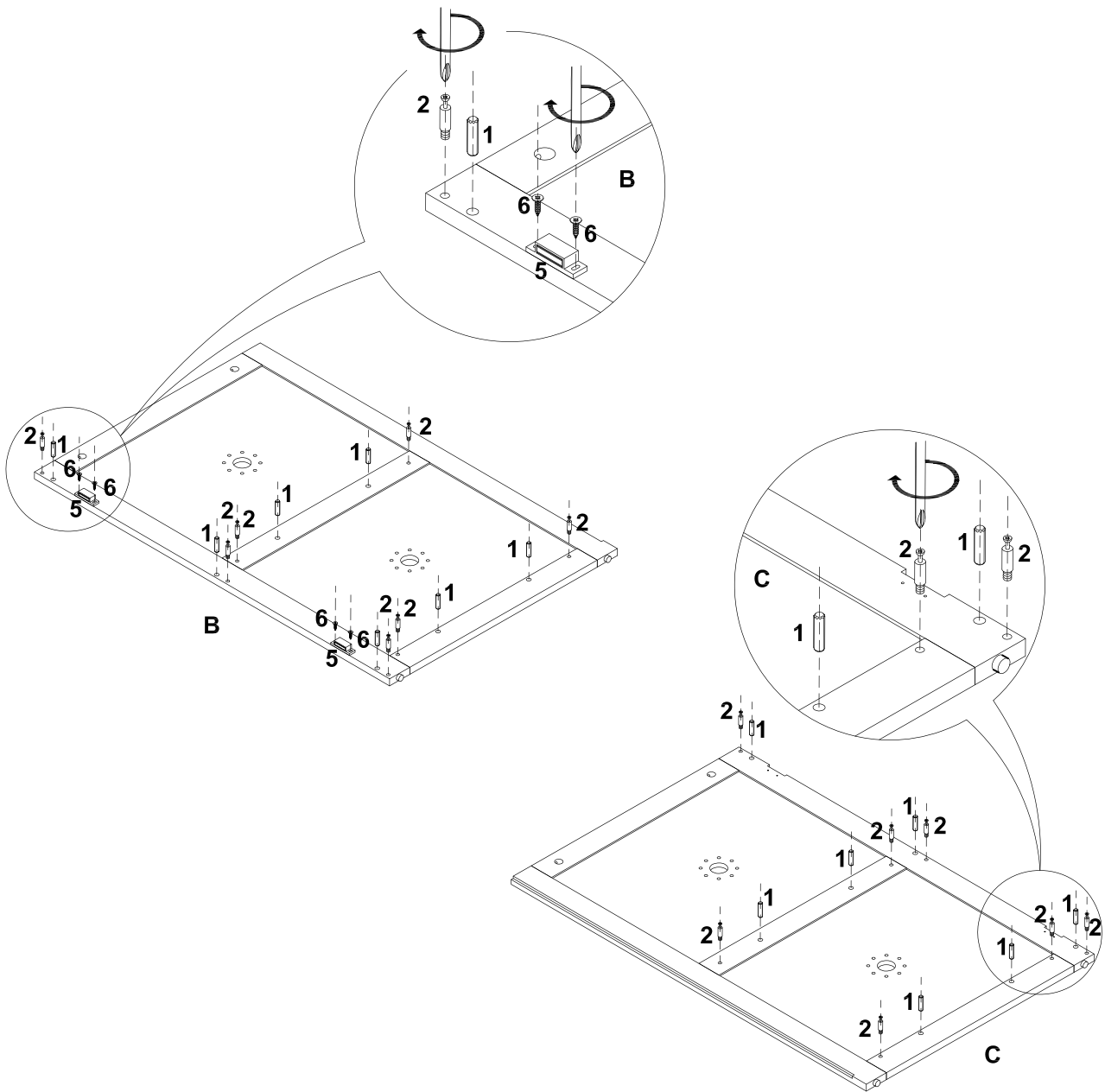

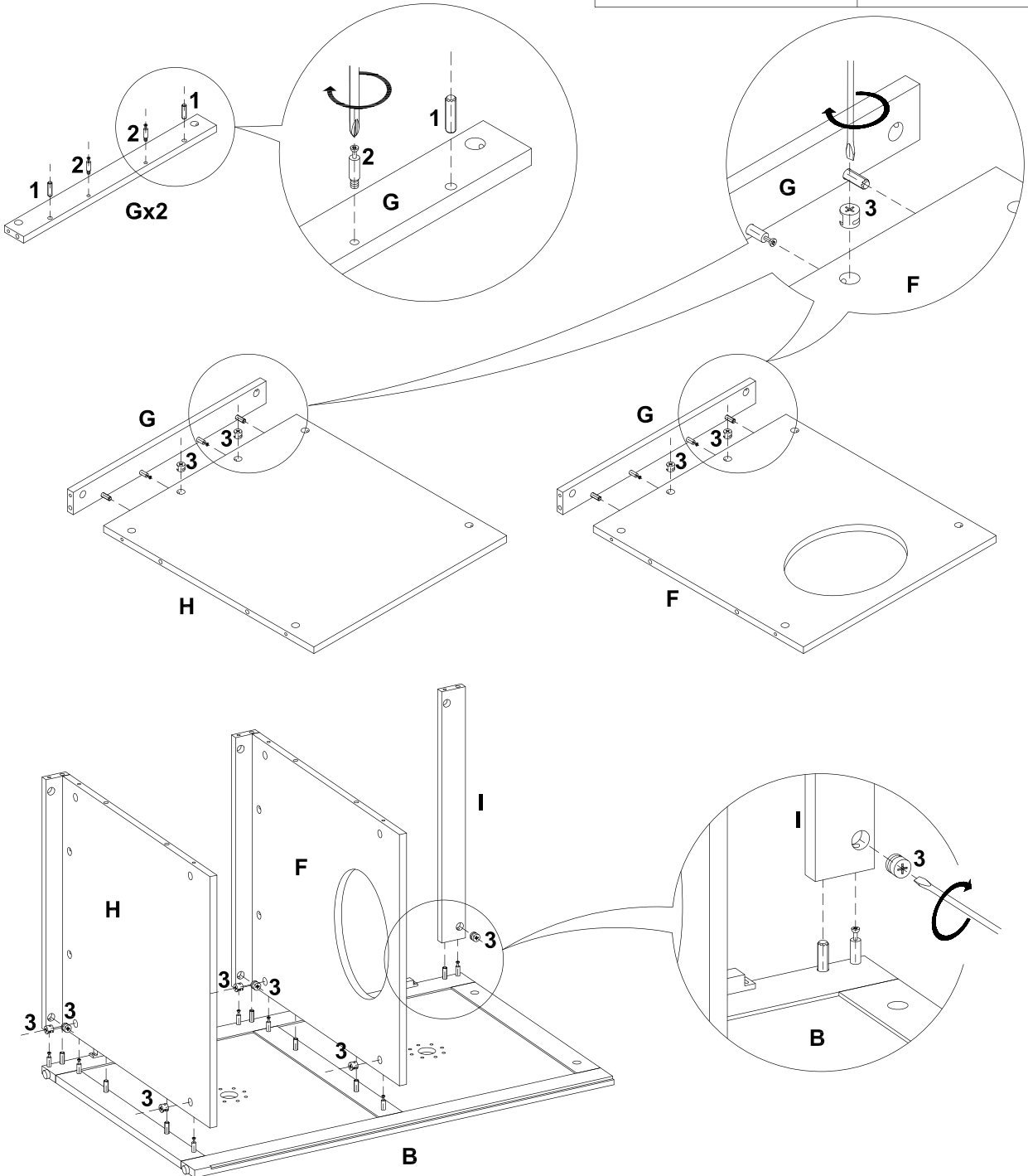
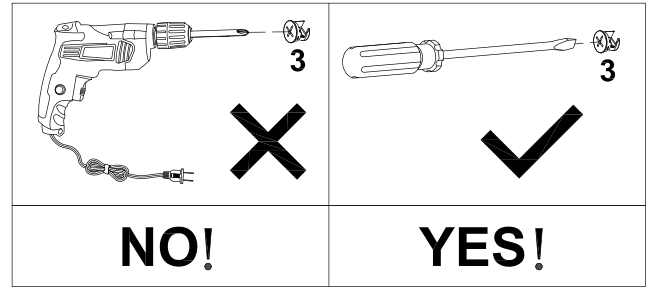
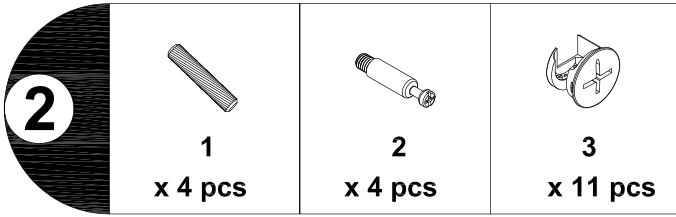
ASSEMBLY INSTRUCTIONS

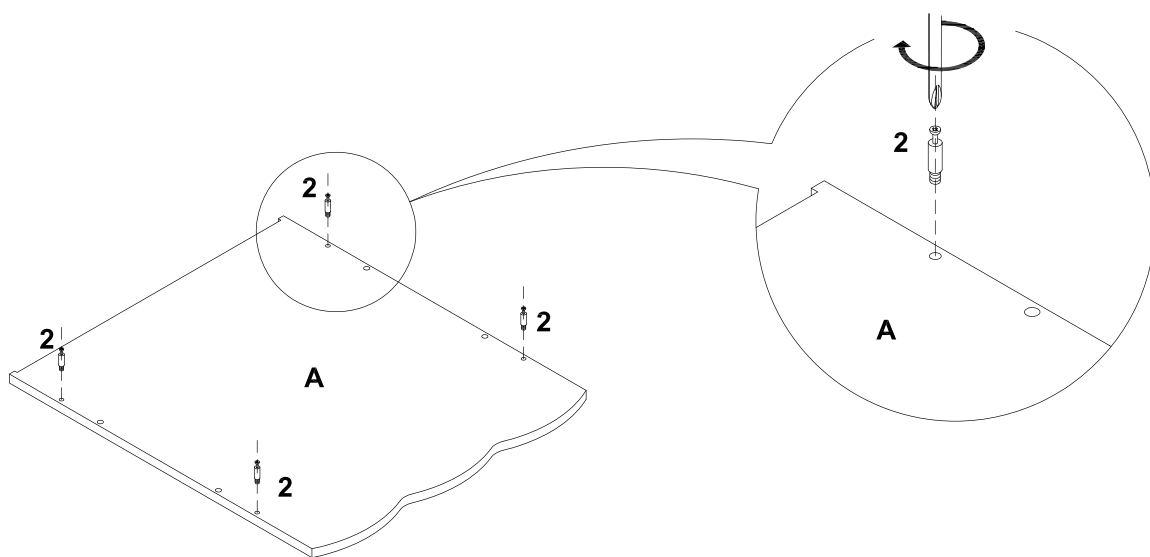
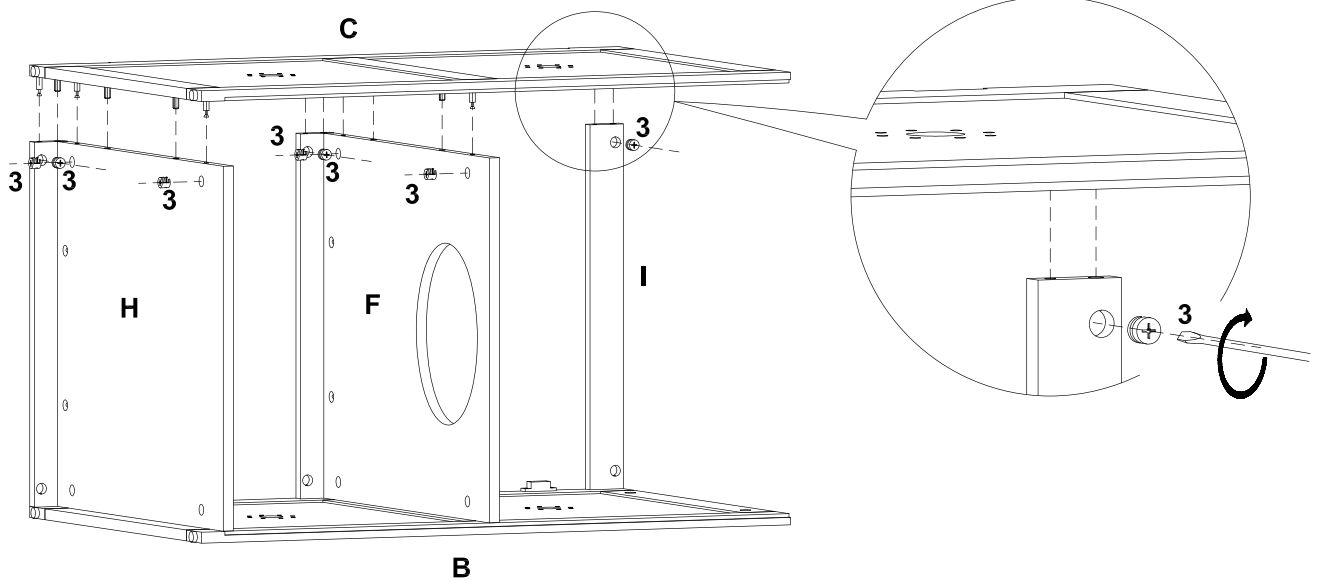
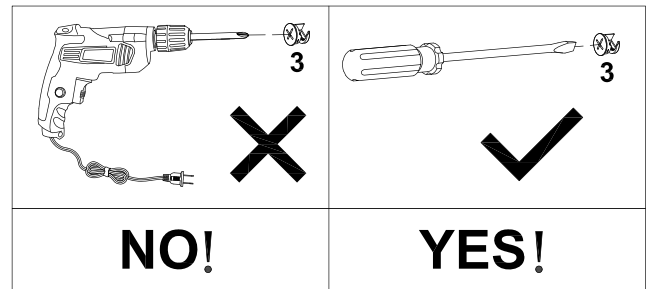
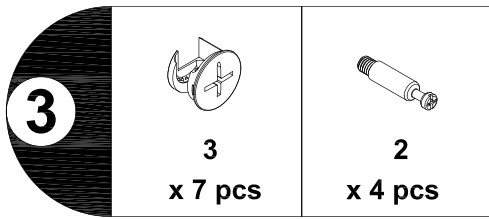
1				
	1	2	5	6
	x 14 pcs	x 14 pcs	x 2 pcs	x 4 pcs







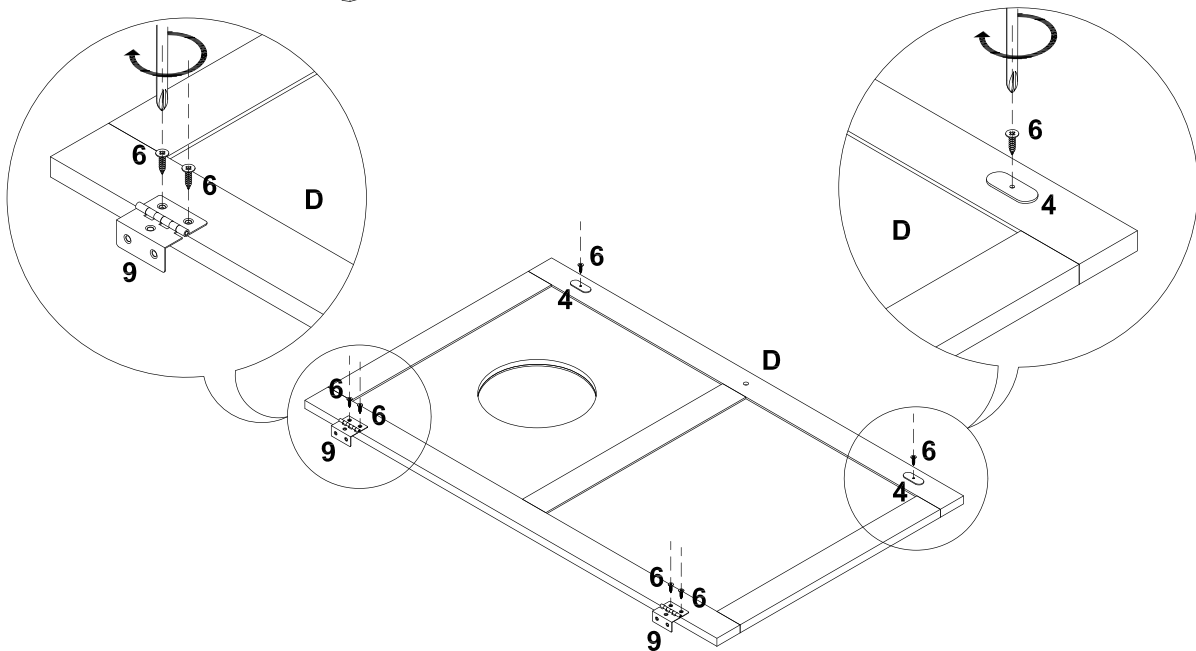
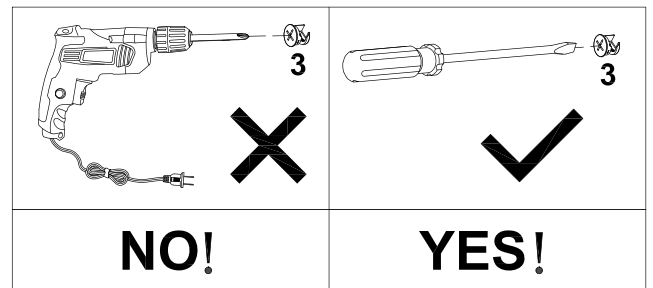
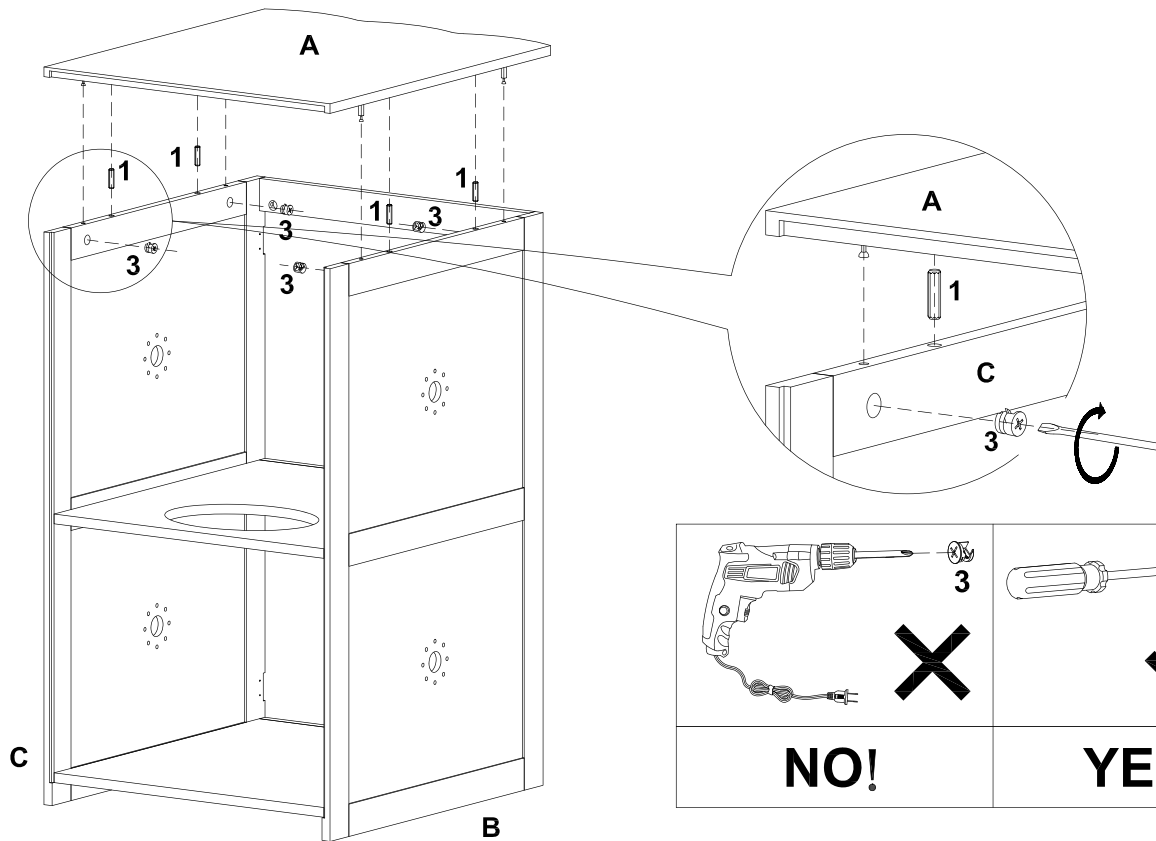

4	 1 x 4 pcs	 3 x 4 pcs	 4 x 2 pcs	 6 x 6 pcs	 9 x 2 pcs
---	--	--	--	--	--



5	 7 x 1 pc	 8 x 1 pc	 6 x 6 pcs
---	---	---	--

