

**TRIXIE**

## **Aufbauanleitung und Stückliste / Assembling Instructions and Parts List**

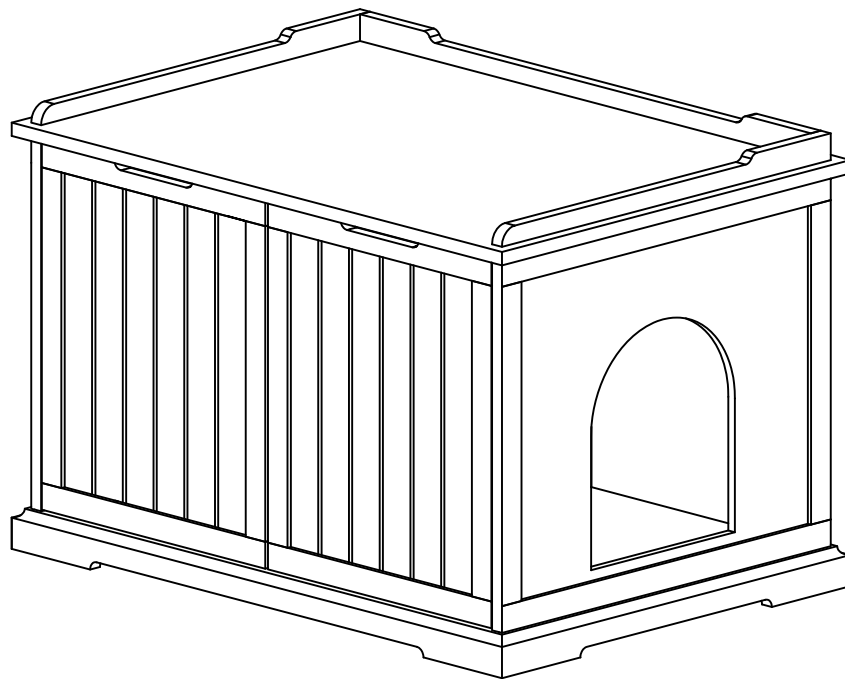

Art.-Nr. / Item No.		Farbe / Colour	Größe / Size	
40233	Katzenhaus für Katzentoilette XL / Cat Toilet House XL	weiß / white	75 x 51 x 53 cm	

Pos. Nr. / Pos. No.	Bezeichnung / Description	Abmessung in mm / Measurement in mm	Anzahl / Quantity	Art. Nr. / Item No.
Pos. A	Seitenleiste für Dachplatte / Side aprons for Top Panel	498 x 30 x 15	2	40233-22
Pos. B	Leiste für Dachplatte, hinten / Apron for Top Panel, back	690 x 30 x 15	1	40233-23
Pos. C	Dachplatte / Top Panel	750 x 533 x 15	1	40233-20
Pos. D	Seitenteil / Side Panel	510 x 415 x 14	1	40233-11
Pos. E	Trennwand / Divider Panel	473 x 415 x 10	1	40233-12
Pos. F	Seitenteil mit Eingang / Side Panel with Entry	510 x 415 x 14	1	40233-10
Pos. G	Rückwand / Back Panel	695 x 415 x 12	1	40233-40
Pos. H	Türplatte, links / Door Panel, left	342 x 415 x 14	1	40233-30
Pos. I	Türplatte, rechts / Door Panel, right	342 x 415 x 14	1	40233-31
Pos. J	Bodenplatte / Bottom plate	750 x 533 x 45	1	40233-21
Pos. 1	Dübel / Dowel	ø 6 x 30	14	40233-50
Pos. 2	Bolzen für Korpusverbinder / Bolt for Cam Lock	M6 x 35	14	
Pos. 3	Korpusverbinder / Cam Lock	ø 15 x 10	14	
Pos. 4	Verschluss, magnetisch / Closing Latch, magnetic		2	
Pos. 5	Senk-Holzschraube / Countersunk wood screw	4 x 30	6	
Pos. 6	Senk-Holzschraube / Countersunk wood screw	3 x 12	24	
Pos. 7	Scharnier / Hinge		4	

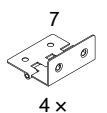
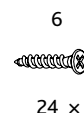
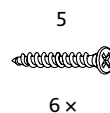
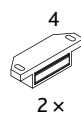
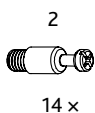
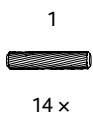

**DE Hinweis:**

Setzen oder stellen Sie sich nicht auf den Home Kennel.  
 Der Home Kennel ist nur für Haustiere gedacht.  
 Der Eingang kann wahlweise rechts oder links eingebaut werden.  
 Dieser Artikel sollte von einer erwachsenen Person aufgebaut werden.  
 Sie finden eine französische und italienische Anleitung unter der jeweiligen Artikelnummer auf [www.trixie.de](http://www.trixie.de).

**EN Advice:**

Do not sit or stand on this product. It is intended for pets only.  
 The entrance can be installed either on the right or on the left.  
 This product should be assembled by an adult.  
 Please find instructions in French and Italian under the corresponding item number at [www.trixie.de/en](http://www.trixie.de/en).





**FR Conseil:**

Vous trouverez les informations détaillées en français et en italien à chaque référence d'article, sur notre site [www.trixie.fr](http://www.trixie.fr).

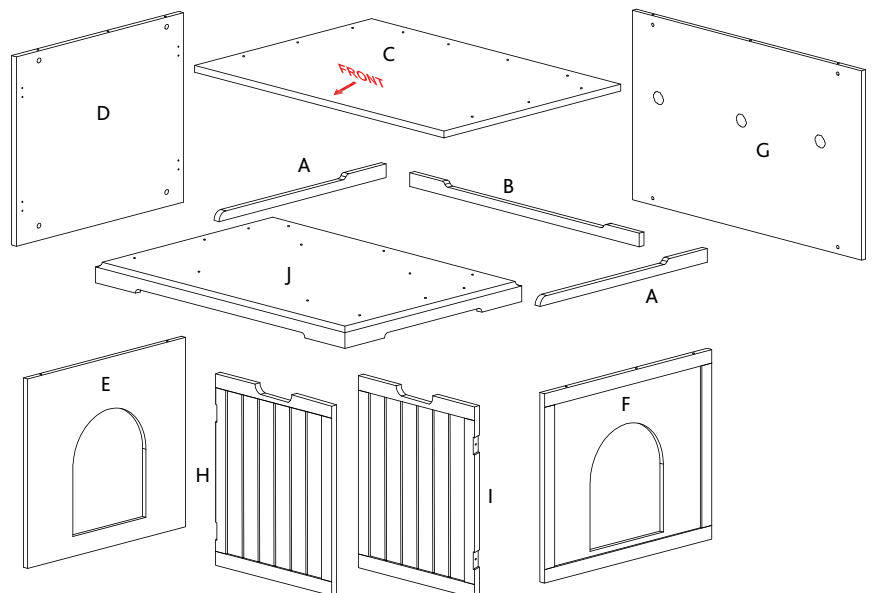

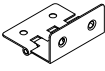

**IT Nota:**

Le istruzioni in italiano e francese sono disponibili selezionando il codice dell'articolo sul nostro sito [www.trixie.it](http://www.trixie.it).

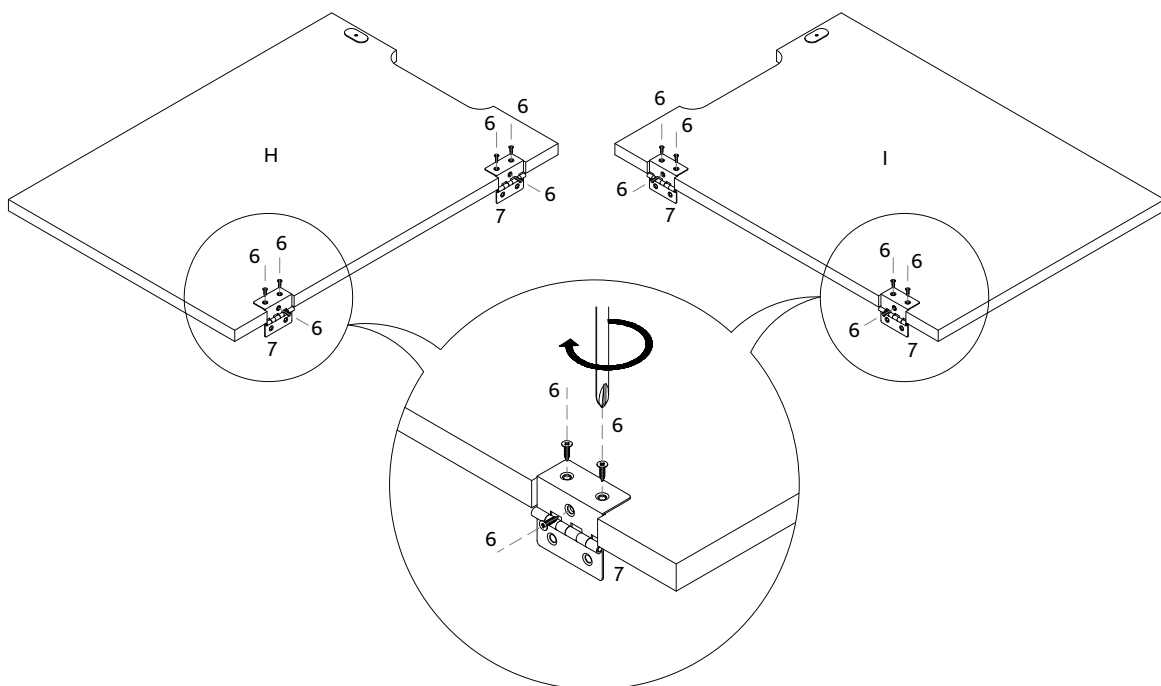
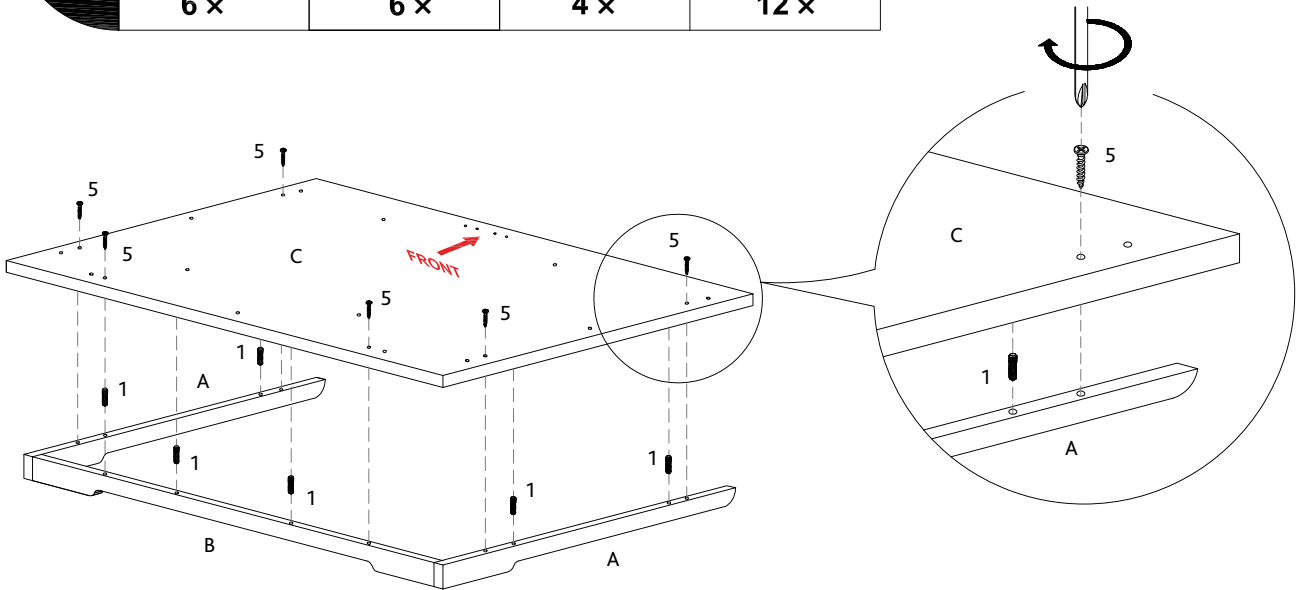

1				
	1 6 x	5 6 x	7 4 x	6 12 x



2				
	1 3 x	2 14 x	4 2 x	6 4 x

