

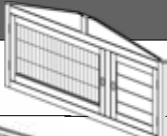

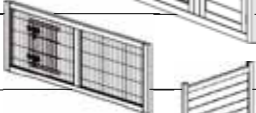

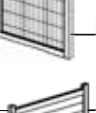

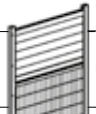



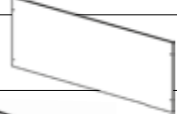
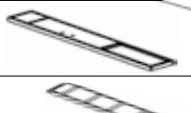
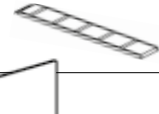

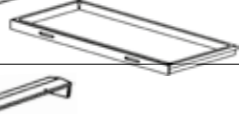

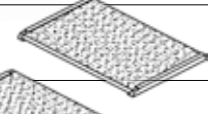
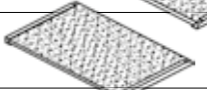
Art.-Nr. / Item No.	Kleintierstall / Small Animal Hutch	Farbe / Colour
62321		braun / brown
62344		grau / grey

Pos. Nr. / Pos. No.	Bezeichnung / Description	Abmessung in mm / Measurement in mm	Anzahl / Quantity	Art. Nr. / Item No.	Karton Nr. Carton No.
Pos. 1	Vorderteil inkl. Tür, oben / Front parts with door, top	 1110 x 470 x 25 mm	1	62321-10 62344-10	1
Pos. 2	Vorderteil, unten / Front part, bottom	 1110 x 450 x 25 mm	1	62321-11 62344-11	1
Pos. 3	Seitenteil, links / Side panel, left	 900 x 665 x 25 mm	1	62321-30 62344-30	2
Pos. 4	Seitenteil, rechts / Side panel, right	 900 x 665 x 25 mm	1	62321-31 62344-31	2
Pos. 5	Rückwand, oben / Back wall, top	 1160 x 620 x 12 mm	1	62321-20 62344-20	1
Pos. 6	Rückwand, unten / Back wall, bottom	 1160 x 460 x 12 mm	1	62321-21 62344-21	1
Pos. 7	Hintere Bodenplatte / Rear hatch	 1105 x 180 x 25 mm	1	62321-42 62344-42	1
Pos. 8	Rampe / Ramp	 960 x 145 x 20 mm	1	62321-41 62344-41	1
Pos. 9	Trennwand / Partition	 605 x 400 x 8 mm	1	62321-32 62344-32	2
Pos. 10	Ausziehbare Bodenwanne / Drawer with plastic inlay	 1105 x 480 x 55 mm	1	62321-40 62344-40	1
Pos. 11	Dachfirst / Roof ridge	 790 x 90 x 60 mm	1	62321-52 62344-52	1
Pos. 12	Dachhälfte, links / Roof part, left	 755 x 620 x 50 mm	1	62321-50 62344-50	2
Pos. 13	Dachhälfte, rechts / Roof part, right	 755 x 620 x 50 mm	1	62321-51 62344-51	2

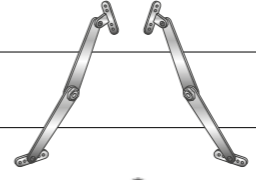
Pos. Nr. / Pos. No.	Bezeichnung / Description	Abmessung in mm / Measurement in mm	Anzahl / Quantity	Art. Nr. / Item No.
A	Senkkopfschraube Countersunk screw 	ø 3,5 x 50 mm	12+1	62321-60
B	Senkkopfschraube Countersunk screw 	ø 3,5 x 30 mm	8+1	
C	Senkkopfschraube Countersunk screw 	ø 3 x 16 mm	2+1	
D	Senkkopfschraube Countersunk screw 	ø 3,5 x 22 mm	4+1	
E	Fangband, rechts Check strap, right  plus je 8 Schrauben F plus 8 screws F for each	280 mm	1/1	
F	Linskopfschraube Lenshead screw 	ø 3 x 14 mm	16+1	
G	Verschlussriegel Locking bolt  plus 1 Schraube H bolt plus 1 screw H	70 mm	1	
H	Senkkopfschraube Countersunk screw 	ø 3 x 25 mm	1	
I	Verriegelungsherz Lock heart-shaped 	45 x 40 x 7 mm	1	

(DE) Sie finden eine französische und italienische Anleitung unter der jeweiligen Artikel-Nummer auf [www.trixie.de](http://www.trixie.de).  
 (EN) Please find instructions in French and Italian under the corresponding item number at [www.trixie.de/en](http://www.trixie.de/en).  
 (FR) Vous trouverez les informations détaillées en français et en italien à chaque référence d'article, sur notre site [www.trixie.fr](http://www.trixie.fr).  
 (IT) Le istruzioni in italiano e francese sono disponibili selezionando il codice dell'articolo sul nostro sito [www.trixie.it](http://www.trixie.it).  
 info smaltimento: [www.trixieitalia.it](http://www.trixieitalia.it)

- DE Verschrauben Sie das linke und rechte Seitenteil (3/4) mit dem oberen und unteren Vorderteil (1/2).
- EN Screw the left and right side panel (3/4) with the upper and lower front parts (1/2).

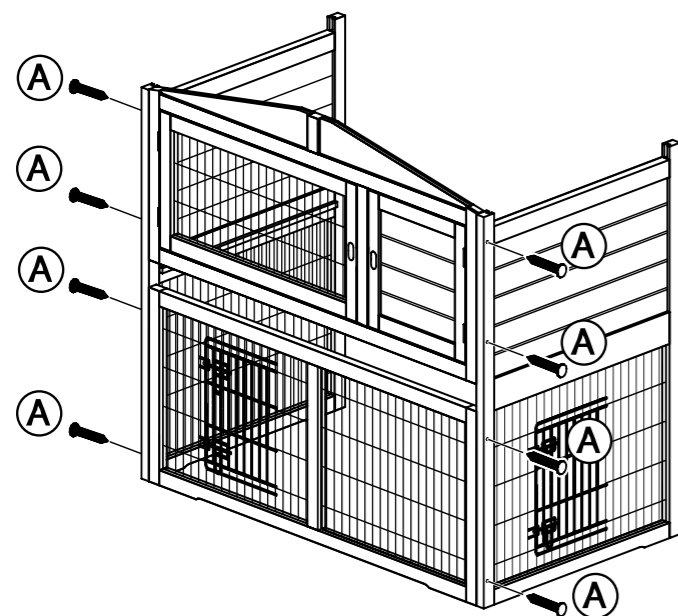

1.

- DE Verschrauben Sie nun die beiden Teile der Rückwand (5/6) mit den Seitenteilen (3/4).
- EN Screw both back walls (5/6) with the side panels (3/4).

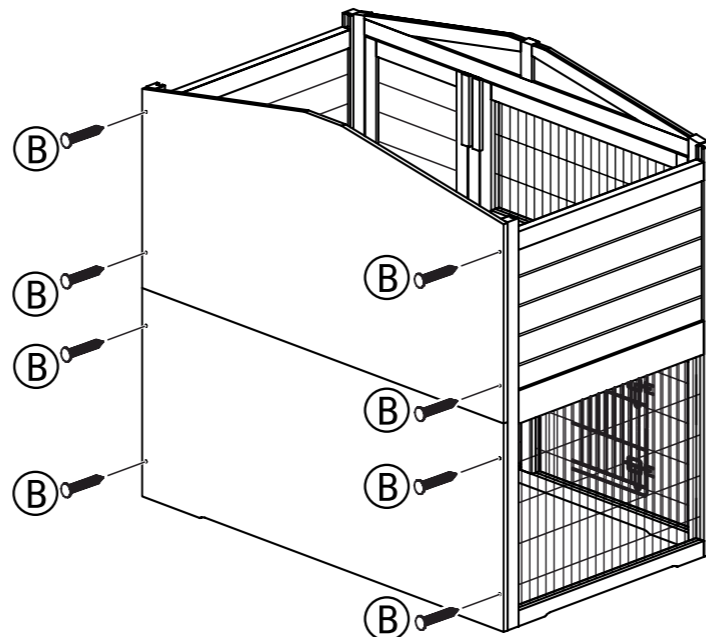

2.

- DE Legen Sie die hintere Bodenplatte (7) ein, schieben Sie die Rampe (8) durch die kleine Öffnung des Bodens und schrauben Sie diese fest.
- EN Insert the rear hatch (7), put the ramp (8) through the small opening and tighten it.

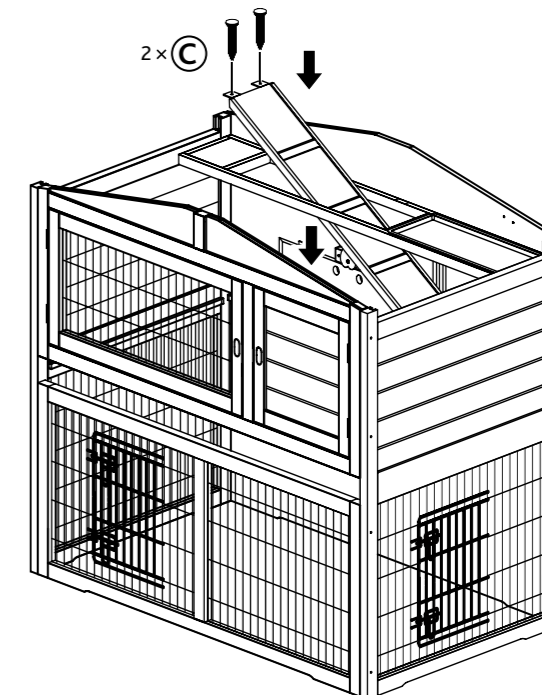

3.

- DE Befestigen Sie das Verriegelungsherz (I) an der oberen Rückwand. Schieben Sie die Trennwand (9) und die ausziehbare Bodenwanne (10) ein.
- EN Fasten the heart-shaped lock (I) on the upper back wall. Insert the partition (9) and the drawer (10).

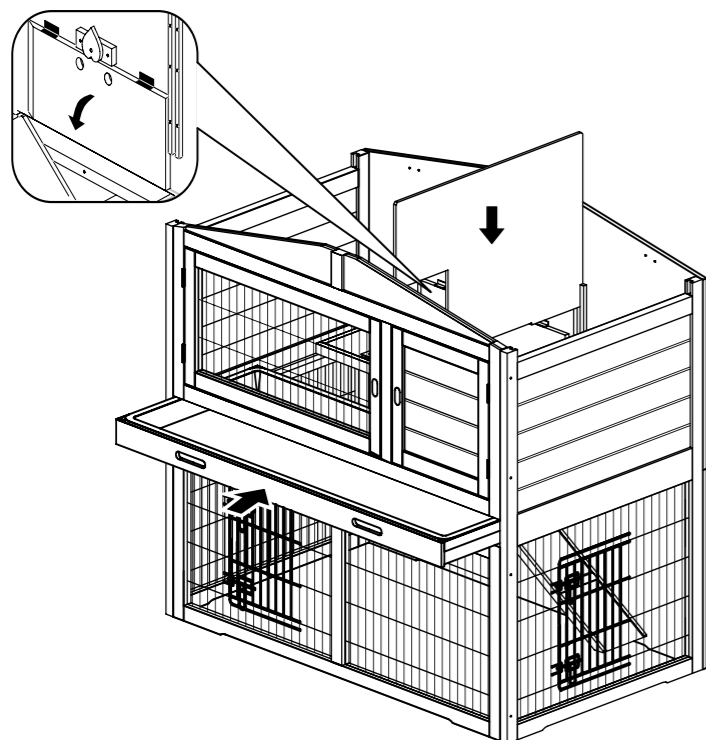

4.

- DE Befestigen Sie die beiden Dachhälften (12/13). Verschrauben Sie die beiden Fangbänder (E) jeweils an den Innenseiten der Dachhälften und der Rückwand. Befestigen Sie den Dachfirst (11) an einer der Dachhälften.
- EN Fix the two parts of the roof (12/13). Screw the check straps (E) to each inner side of the roof parts and the back wall. Fix the ridge (11) to one side of the roof.

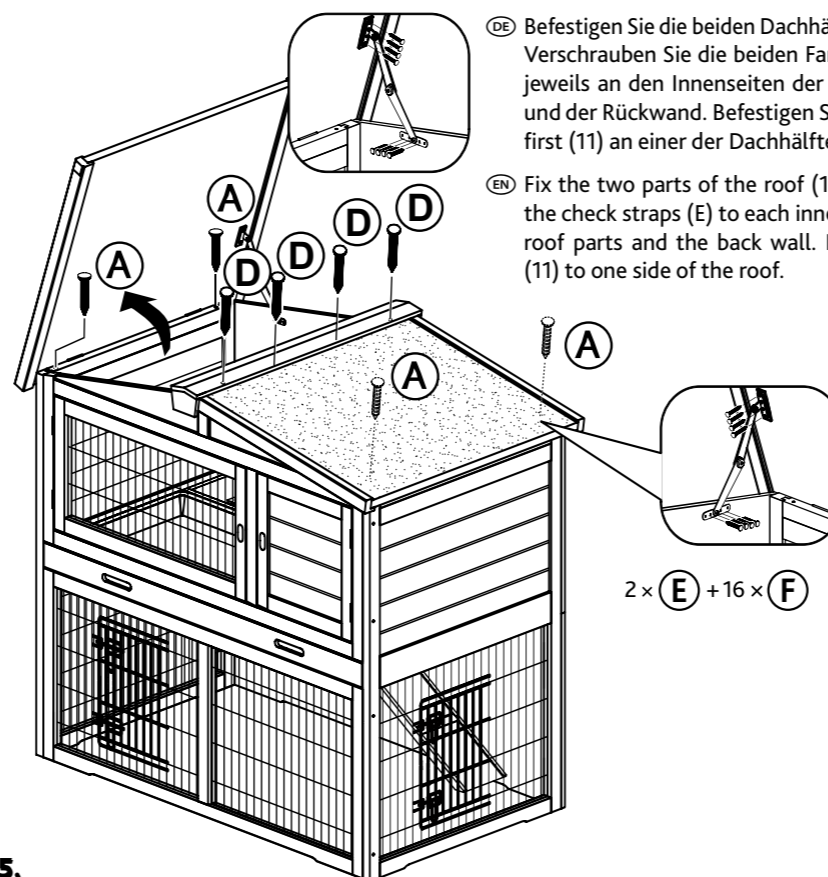

5.

- DE Abschließend schrauben Sie den Verschlussriegel (G) zwischen die Türen.
- EN Screw the locking bolt (G) between the doors.

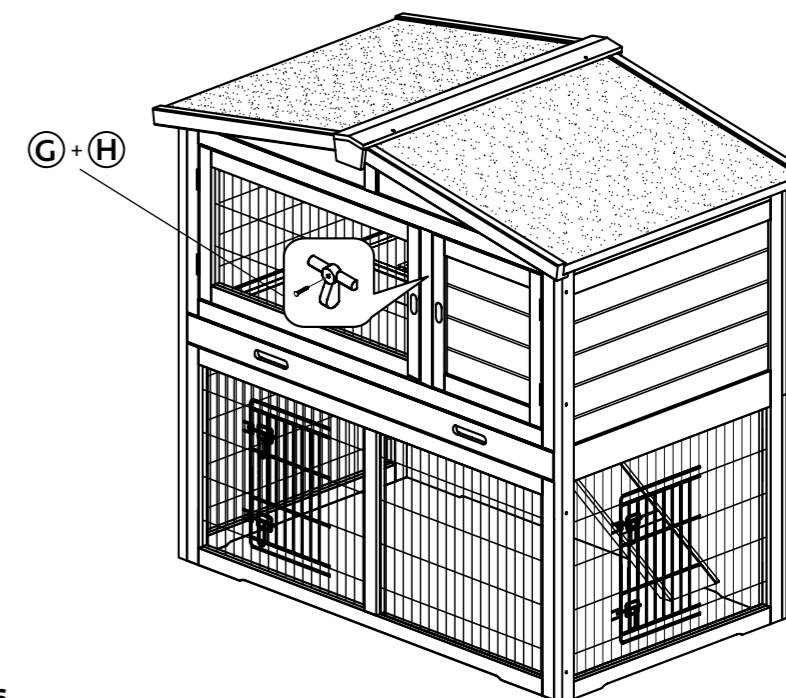

6.