

TRIXIE

Conseils de montage & Pièces détachées / Istruzioni di montaggio & elenco dei pezzi

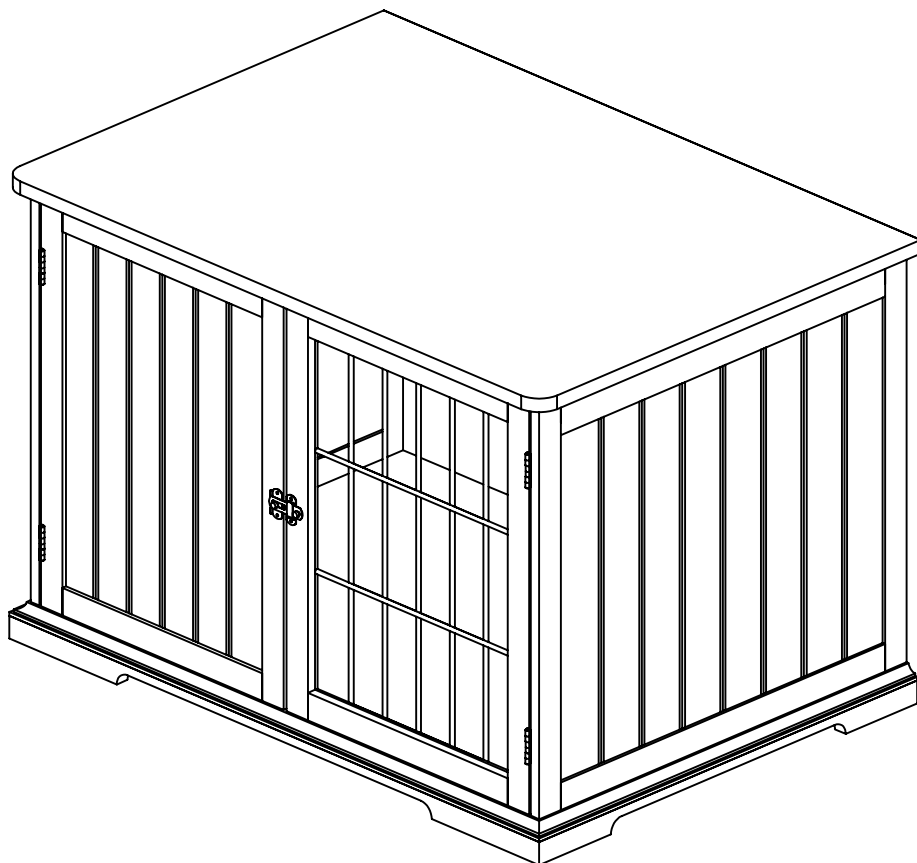



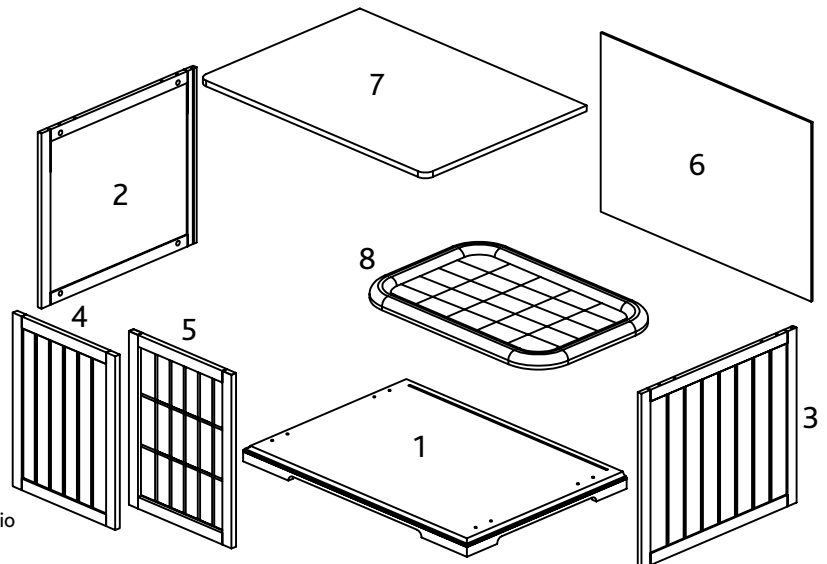
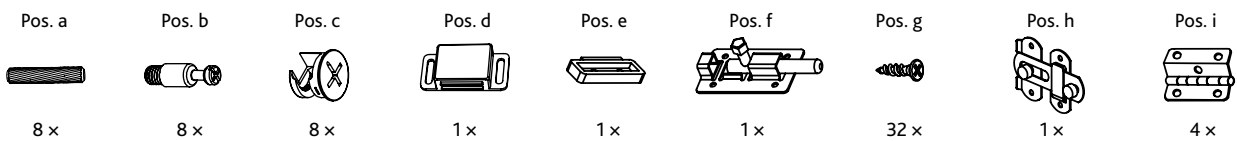

No. d'article / Art. n.		Couleur / Colore	Taille / Dimensione	
39753	Home Kennel	blanc / bianco	72 x 53 x 53 cm	

N° de la liste / Pos. n.	Description / Descrizione	Dimensions en mm / Misura in mm	Quantité / Quantità	No. d'article / Art. n.
Pos. 1	Base / Base	718 x 60 x 530	1	39753-10
Pos. 2	Paroi latérale, gauche / Parete laterale, di sinistra	15 x 453 x 513	1	39753-20
Pos. 3	Paroi latérale, droite / Parete laterale, di destra	15 x 453 x 513	1	39753-21
Pos. 4	Cadre inférieur / Listello frontale	327 x 448 x 15	1	39753-30
Pos. 5	Porte avant / Porta frontale	327 x 448 x 15	1	39753-31
Pos. 6	Panneau arrière / Parete posteriore	668 x 463 x 5	1	39753-40
Pos. 7	Panneau haut / Tetto	727 x 15 x 537	1	39753-50
Pos. 8	Coussin / Cuscino	660 x 500	1	39753-41
Pos. a	Goujon, grand / Tassello, grande	∅ 6 x 30	8	39753-60
Pos. b	Vis pour écrou cam / Perno di giunzione	M6 x 35	8	
Pos. c	Écrou cam / Vite di giunzione	∅ 15 x 10	8	
Pos. d	Aimant de fermeture / Chiusura magnetica		1	
Pos. e	Arrêt de porte, dessous / Fermaporta, il basso		1	
Pos. f	Arrêt de porte, au-dessus / Fermaporta, sopra		1	
Pos. g	Vis à tête fraisée / Vite svasata	M3 x 12	32	
Pos. h	Clapet de fermeture / Chiusura		1	
Pos. i	Charnière / Cerniera		4	





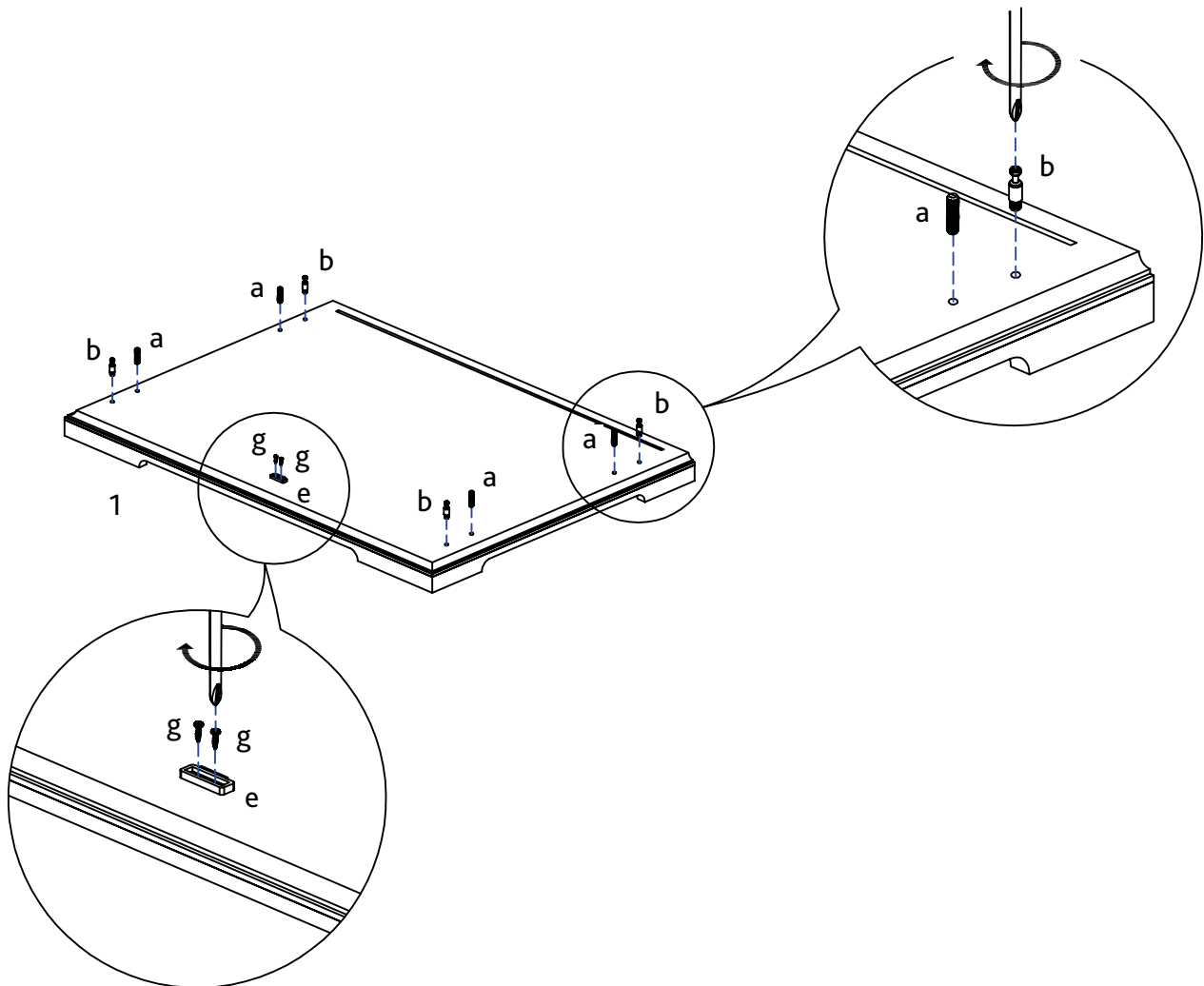

FR Conseil:
 Ne pas s'asseoir ni se poser sur la cabane pour chat.
 La cabane pour chat est uniquement destinée aux animaux.
 Le montage de ce produit doit être réalisé par un adulte.
 Veuillez vérifier régulièrement les vis, et les resserrer si nécessaire.

IT Nota:
 Si prega di non sedersi su questo mobile.
 E' destinato esclusivamente ai pet.
 L'assemblaggio di questo prodotto deve essere effettuato da un adulto.
 Si prega di controllare regolarmente il fissaggio delle viti e se necessario stringerle ancora.

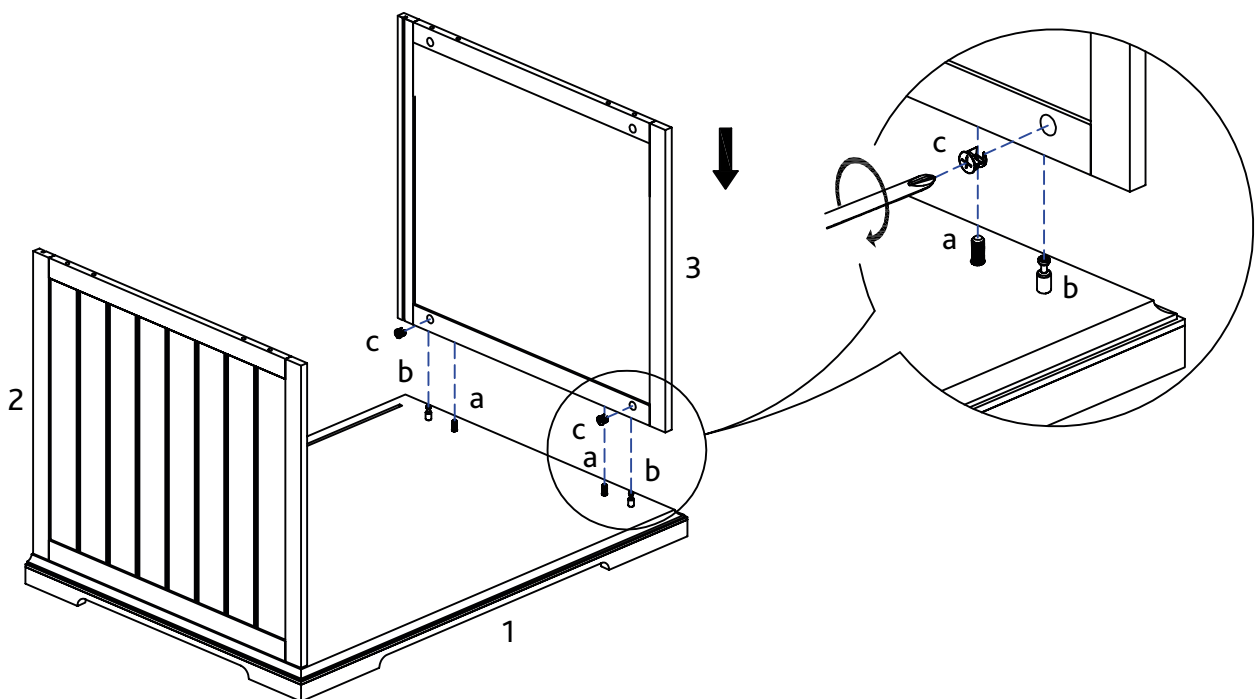
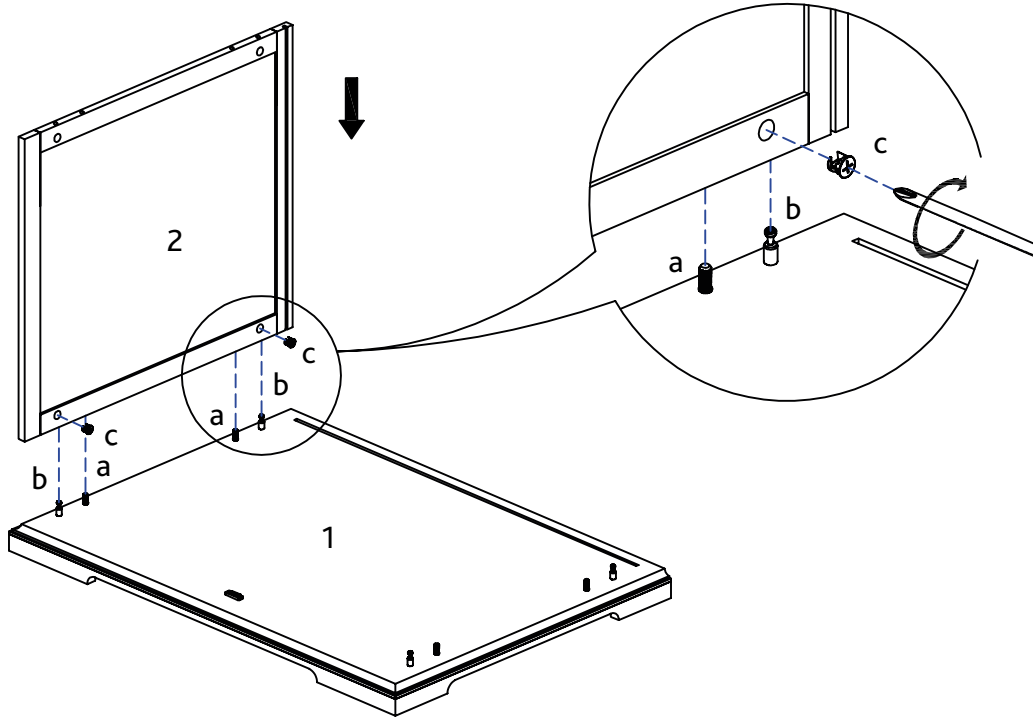
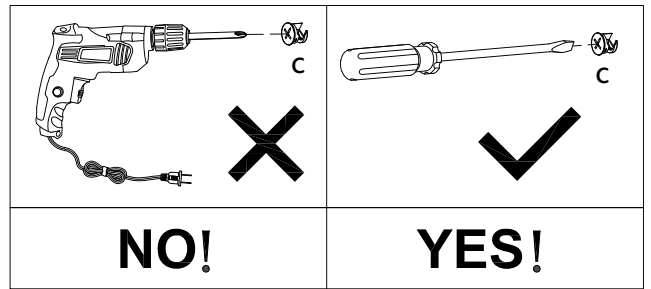
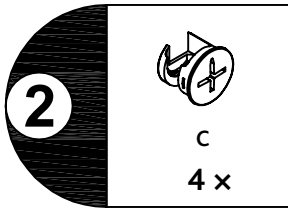
1				
	a 4 x	b 4 x	e 1 x	g 2 x



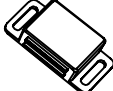

3				
	a 4 x	b 4 x	d 1 x	g 2 x

